

# MY FIRST SKY GUIDE

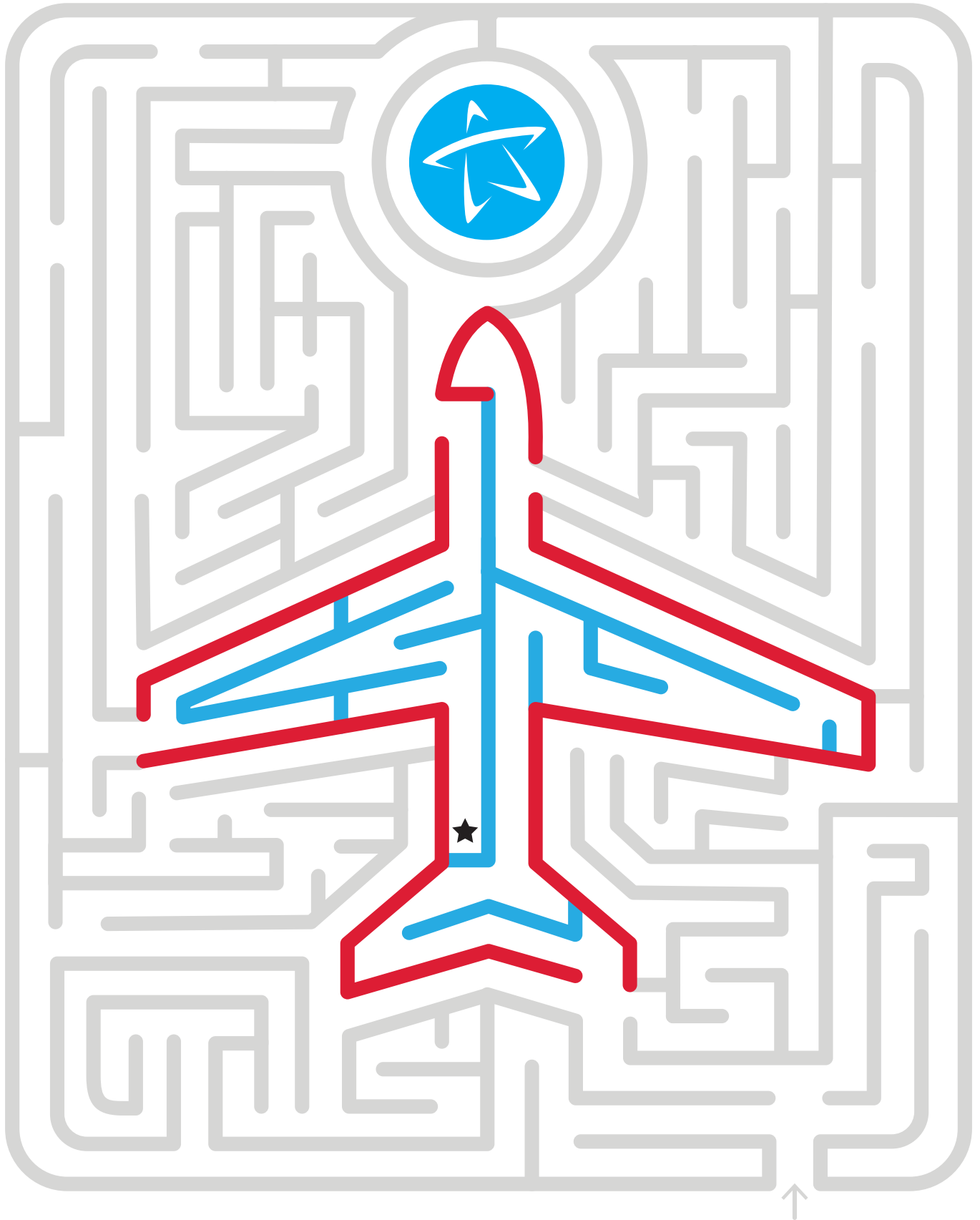

AN ACTIVITY BOOK FOR NEW FLIERS  
CITY OF TALLAHASSEE

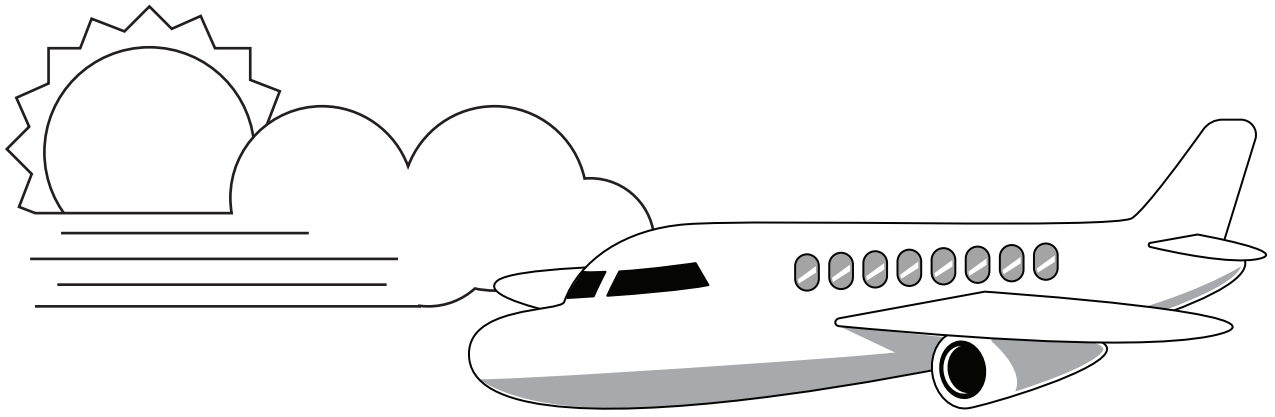

## **FLYING IS FUN!**

Traveling to new places is exciting, but it can also make you feel nervous.

The City of Tallahassee created this book to help show you what to expect between arriving at the airport and reaching your destination.

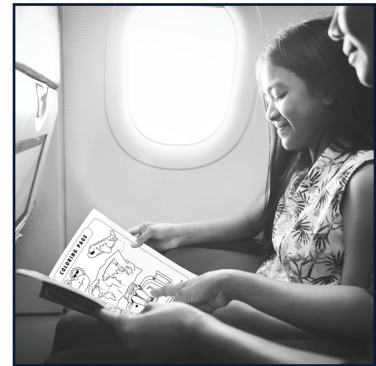
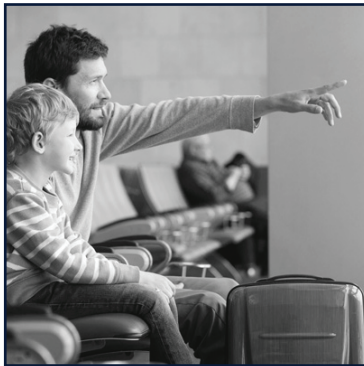

This book is written, produced, and illustrated by the City of Tallahassee.



If you see a box like this one, snap a picture with your smart phone or internet connected smart device for a virtual experience!

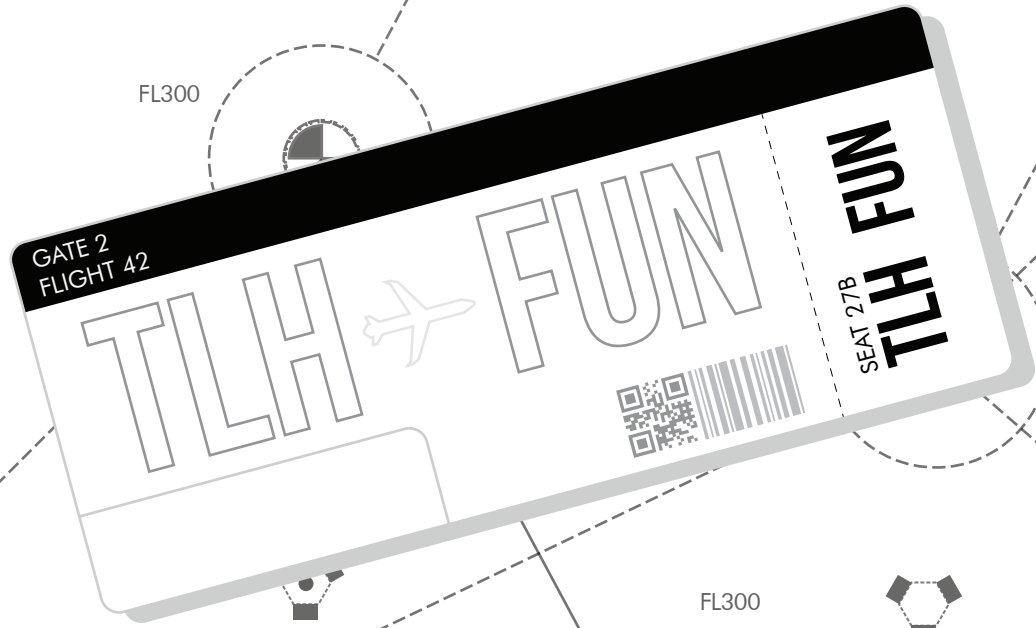

**THIS ACTIVITY BOOK BELONGS TO**

\_\_\_\_\_

What are three things you are looking forward to on your trip?

# PACK YOUR BAGS

Before you go to the airport, pack your bags for your trip! Airplanes have rules about how many bags you can bring to be sure everyone's items fit on the plane.

You can usually bring one, small piece of luggage plus a smaller bag – like a backpack – on the plane. Other luggage gets stored in the bottom part of the plane called the cargo area. Ask your parents to help you pack.

## MIX AND MATCH

Fill the suitcase with the clothes on the right so only one type of garment is in any row and column.

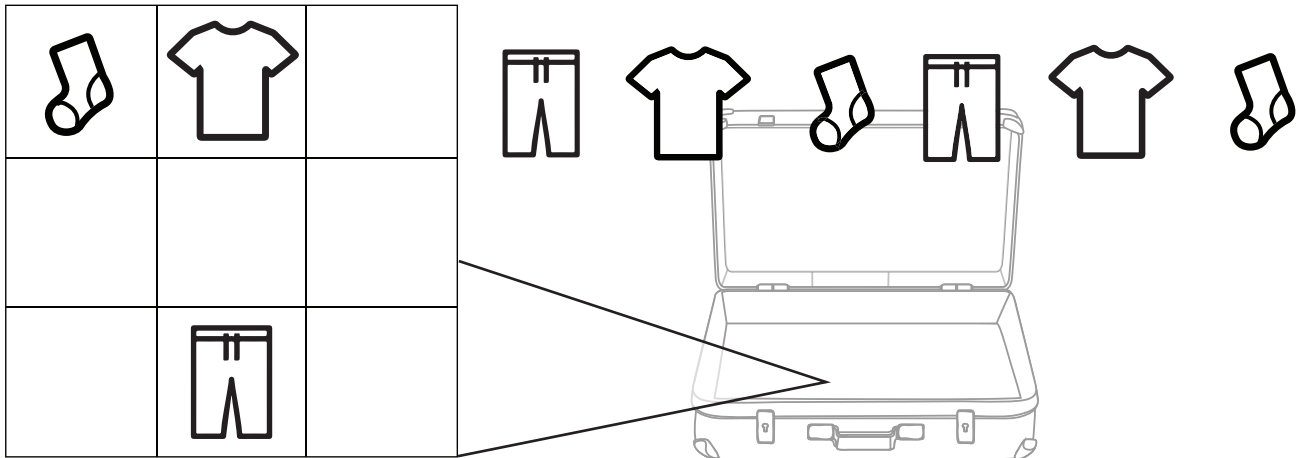

Once you are packed, put your things in the car and head to the airport.



# CHECKING IN

At the airport, you will park the car and head to check-in. Give your name to the person working at the counter, and they will give you a boarding pass.

If you have a large bag that needs to be stored on the bottom part of the plane, you will give it to the person at the check-in counter. They will put a special tag on your luggage, and you will pick it up after you land at your destination.

**DRAW YOUR DESTINATION:**

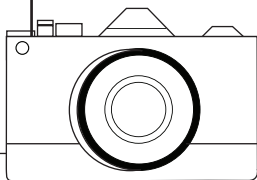

Upload a picture of your drawing to [Talgov.com/AirArt](https://Talgov.com/AirArt) to have it shared with the world!

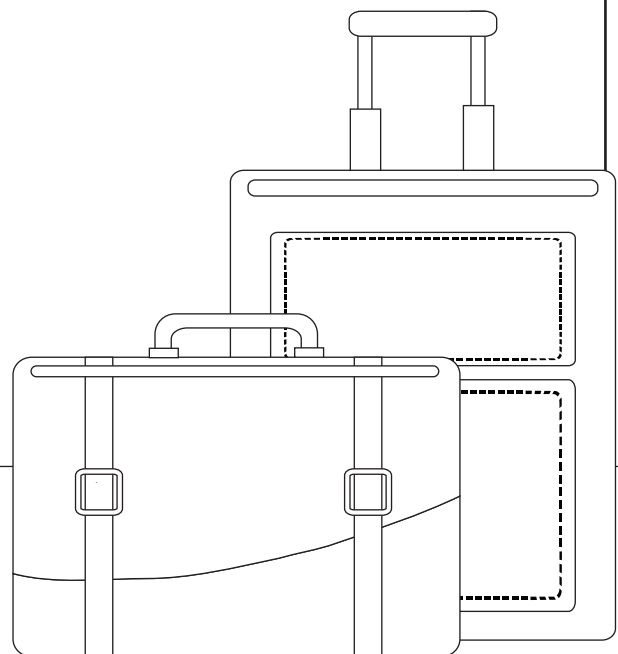

# SECURITY CHECKPOINT

The security checkpoint is a lot of waiting in line. Knowing what to expect will help you get through it.

When you reach the checkpoint, you'll see people in uniforms. They work to keep you safe.

Once it is your turn, the person will check your boarding pass. If you have an ID, they will also look at that.

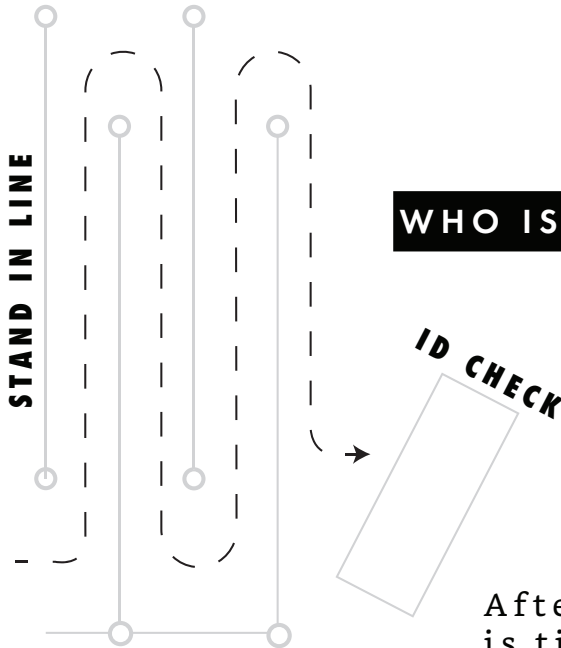

## WHO IS CHECKING YOUR ID?



After your boarding pass is checked, it is time to get your bags scanned!

When you get to the conveyor belt:

- Move everything in your pockets into your bag.
- Keep all electronics and travel-sized liquids in your bag.
- Take off your shoes, jacket and belt and put them in a tray on the conveyor belt.
- Make sure your bags are zipped and all trays with your items go on the conveyor belt.

## WHAT GOES THROUGH THE SCANNER?

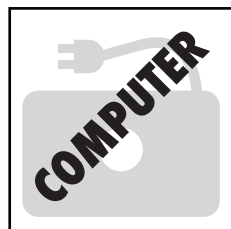
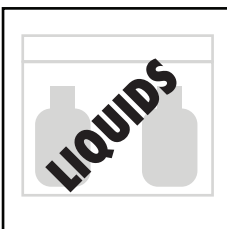

You will get all your stuff back at the end of the security check.

Wait your turn to be called to walk through the body scanner.

A person working at the scanner will tell you what to do next. They might need to wave a wand near your body.

After you and your belongings are scanned, collect your things before you head to the gate!

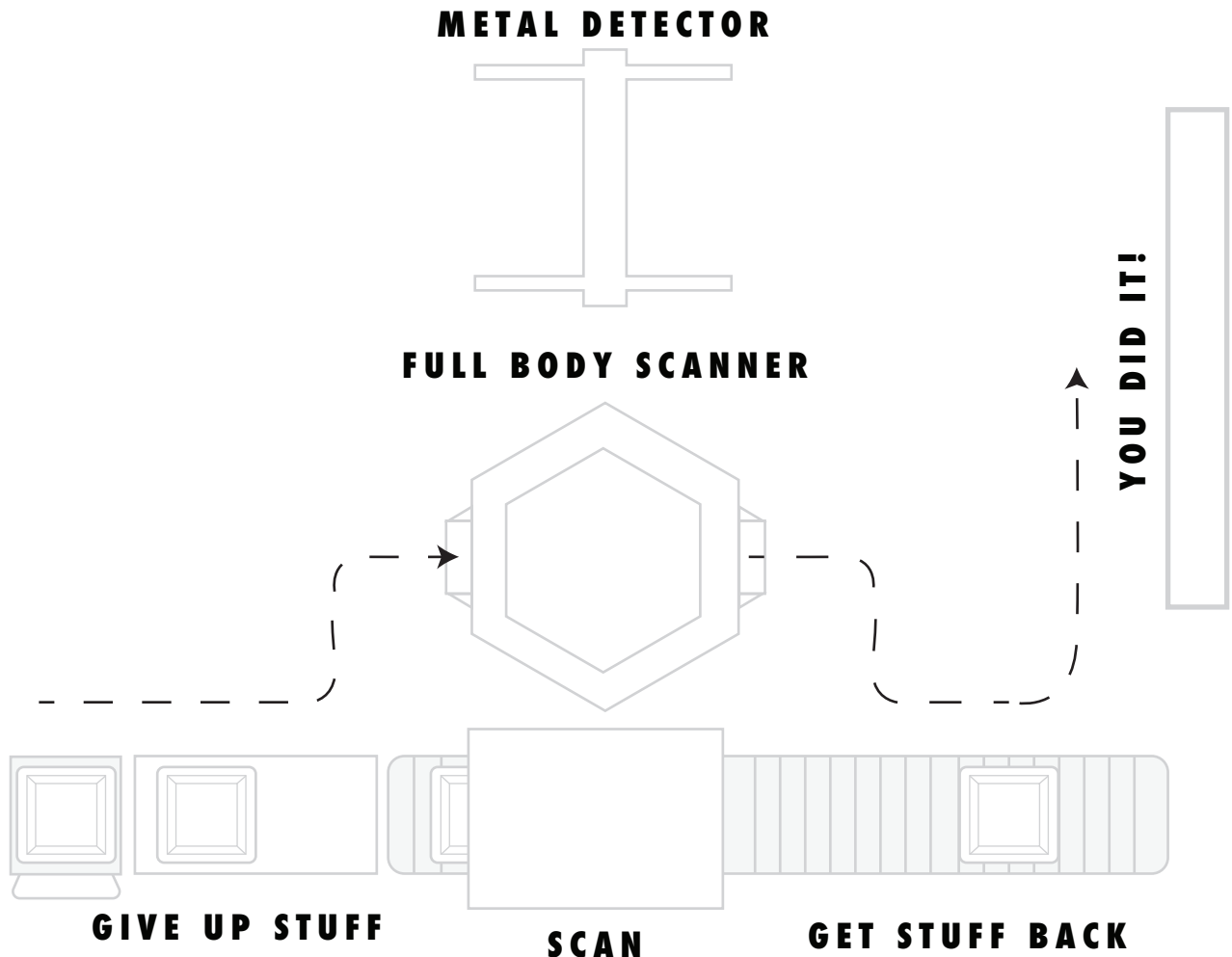

Have questions about the security checkpoint?

Passengers with a disability or medical condition may call ahead to the TSA Cares helpline at (855) 787-2227.

# AT THE GATE

The gate is where you wait until it is time to get on your plane. Your boarding pass will have your gate information on it. You can check you are at the right place by asking a person working at the gate. They're usually behind a desk and wearing a uniform.

MYFLIGHT Boarding Pass				Boarding Pass	
Name of passenger: NEW FLIER	Carrier: MF	Flight No: MF 2547	Class: B	Name of passenger: NEW FLIER	
From: Tallahassee TLH To: Parts Unknown PUN	Date: Today	Luggage Y	Seat: 12B	From: Tallahassee TLH To: Parts Unknown PUN	
<b>GATE</b> B2	<b>BOARDING TIME</b> 02:40			<b>GATE</b> B2	<b>BOARDING TIME</b> 02:40

**B2**

Here are some fun games you can do to pass the time at your gate before you board the plane.

## WORD SEARCH

L S A S A W E B O R K T R O N R B W L T  
 R W I N G E Q K T S A T M B E Y E A O C  
 B S R R H E R B A G G A G E C L A I M A  
 M T C C A E B L I N K I E L E A K R W R  
 I K R H D P L A D D E R T K I R O T O R  
 N A A Y S R A I I P P S U J E Z U S A Y  
 M R F S E O N J P T O I M N A O Z K S O  
 U C T T R P D E C A T D L T W T P Y A N  
 S T K M A E R R E H D E O O K A I C S P  
 R G O G G L E S O S E J A E T A Y A L U  
 W D T W T L W I J E L C Q K T K W P H R  
 J G U B E E N R T F T O K A B A G K D B  
 A T A A R R I V A L S M T P D A O W T W  
 R W E S E S K Y O P L A N E O E E R A S  
 G D R W C O P I L O T E R T E I T J R T  
 A N A P A S S E N G E R S O A N N E A W  
 R E V E A K R T R E V O R K R A P T E L

AIRCRAFT  
 AIRSIDE  
 ARRIVALS  
 BAGGAGE CLAIM  
 CARRYON  
 CHECKPOINT  
 COPILOT  
 GOGGLES  
 HELIPAD  
 JET  
 LADDER  
 PASSENGER  
 PILOT  
 PLANE  
 PROPELLER  
 ROTOR  
 RUNWAY  
 SKYCAP  
 TOWER  
 WING



# COLORING PAGE

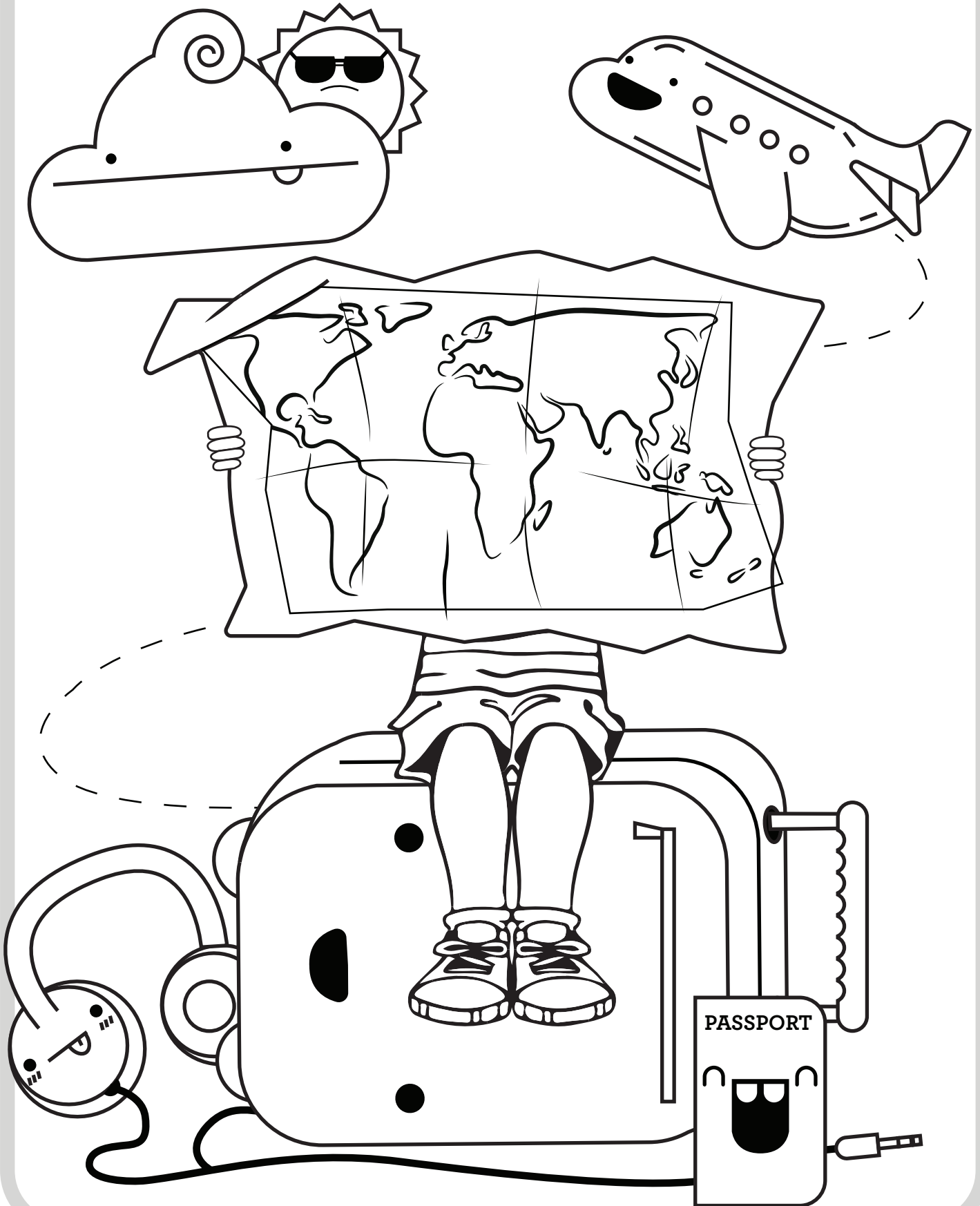

# BOARDING



Your boarding pass shows a group number or letter. When your group is called to board, grab your belongings and get in line. A person will scan your boarding pass and send you through the door to the jet bridge.

The jet bridge is an enclosed walkway that leads to the airplane.

Your ticket shows your assigned row and seat number.



## WHERE DO MY BAGS GO?

There are two places in the plane where you can put your carry-on luggage. A larger item will go in the storage space above your seat and should stay there while the plane is in the air. A smaller item, like a backpack, will go under the seat in front of you.



Make sure you put anything you would like to use during the flight in your small bag.

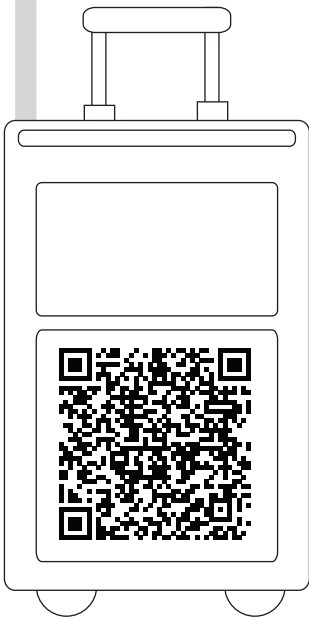

## WORD JUMBLE

Unscramble the words.

- UGGLEGA \_\_\_\_\_
- VEAOEHDR \_\_\_\_\_
- TCTIEK \_\_\_\_\_
- ARCRY NO \_\_\_\_\_
- TJE GDIBER \_\_\_\_\_
- ATES \_\_\_\_\_

# SEATING

While you're in your seat on the plane, you can read, color, or use a small electronic device as long as it is in airplane mode. A flight attendant will announce when it is okay to use a laptop.



**REMEMBER:** If you see the seatbelt light on, make sure you are buckled. The seatbelt light keeps you safe, especially during takeoff, landing, or if the air gets a little bit bumpy.



## FRIENDLY FLIGHT ATTENDANTS

A flight attendant will make important announcements and can answer questions. They may also bring you a snack or drink. Flight attendants have important work to do during a flight so try to be patient when you need their help.

## VISITING IN-AIR BATHROOMS

Plane bathrooms are smaller than yours at home. If you need to use one, make sure the seatbelt light is off. Check the sign near the bathroom door - if it is green, you can go in. If it is red, another passenger is using the bathroom so you will need to wait your turn.

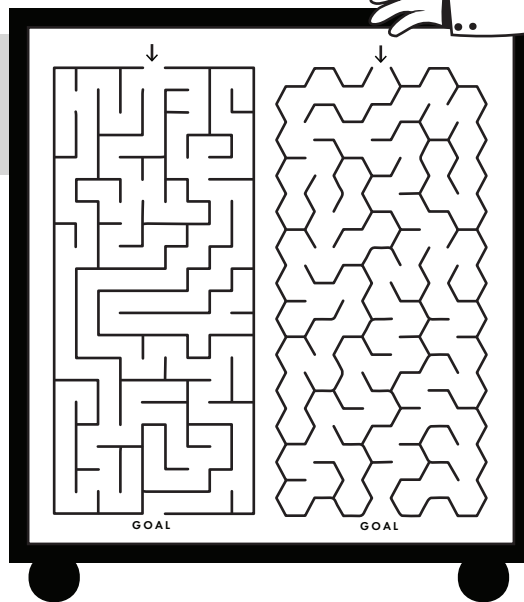

# ON THE PLANE REVIEW

## SEATBELT

Keep it on when you are in your seat and when the light is on.

## LUGGAGE

Things you do not need = overhead  
Things you need = under seat

## TAKE-OFF

Be ready for the plane to go fast.  
Sit in your seat with your seatbelt on.

## BATHROOM

Check the seatbelt light and make sure the green sign is next to the bathroom door.

## ELECTRONICS

You can play with electronics as long as they are in airplane mode.

## FOOD/DRINK

A flight attendant usually can give you some or you may eat snacks you packed.

## LANDING

The pilot will come on the loudspeaker and announce when it is time to land. Be ready for the plane to slow down. Sit in your seat with your seatbelt on. You will feel a small bump when the plane's wheels touch the ground, then the plane will put on the brakes. This sometimes makes your body lean forward a bit, but not for long.

# ONE IN A CROWD

In each grid, cross out any letter that appears MORE THAN ONCE. The remaining letters spell out three things you'll find at an airport.

G	E	R	K	H
D	Y	P	B	F
R	F	M	Z	A
B	I	G	J	X
U	W	K	L	Q
X	M	A	E	U
O	H	T	D	Y
W	Q	Z	J	S

C	M	J	B	D
O	X	A	Y	R
Q	P	N	S	Z
G	B	T	G	U
B	Q	D	H	O
U	Z	X	A	Q
H	J	E	P	M
S	W	N	T	Y

H	S	G	O	B
C	T	J	D	X
K	L	M	F	I
R	M	O	P	Q
L	I	K	X	U
F	N	J	H	G
Q	D	C	W	B
P	A	T	Y	S

# SUDOKU

Fill in the boxes so each of the 4 rows, each of the 4 columns, and each of the 4 Boxes all contain the numbers 1 - 4.

		1	
	4		
	3		
			2

Fill in the boxes so each of the 6 rows, each of the 6 columns, and each of the 6 Boxes all contain the numbers 1 - 6.

3	5				
		4			
	1		3		
		2			
				3	
					6

# WORD SCRAMBLE

**TALLAHASSEE**

Form as many 3 - 8 letter words (no proper names) as you can using the letters from the word Tallahassee. Can you fill all 32 blanks?

_____	_____	_____	_____
_____	_____	_____	_____
_____	_____	_____	_____
_____	_____	_____	_____
_____	_____	_____	_____
_____	_____	_____	_____
_____	_____	_____	_____
_____	_____	_____	_____

# ARRIVAL

After landing you will have to wait your turn to get off the plane. Grab all your bags and walk to the front of the plane.

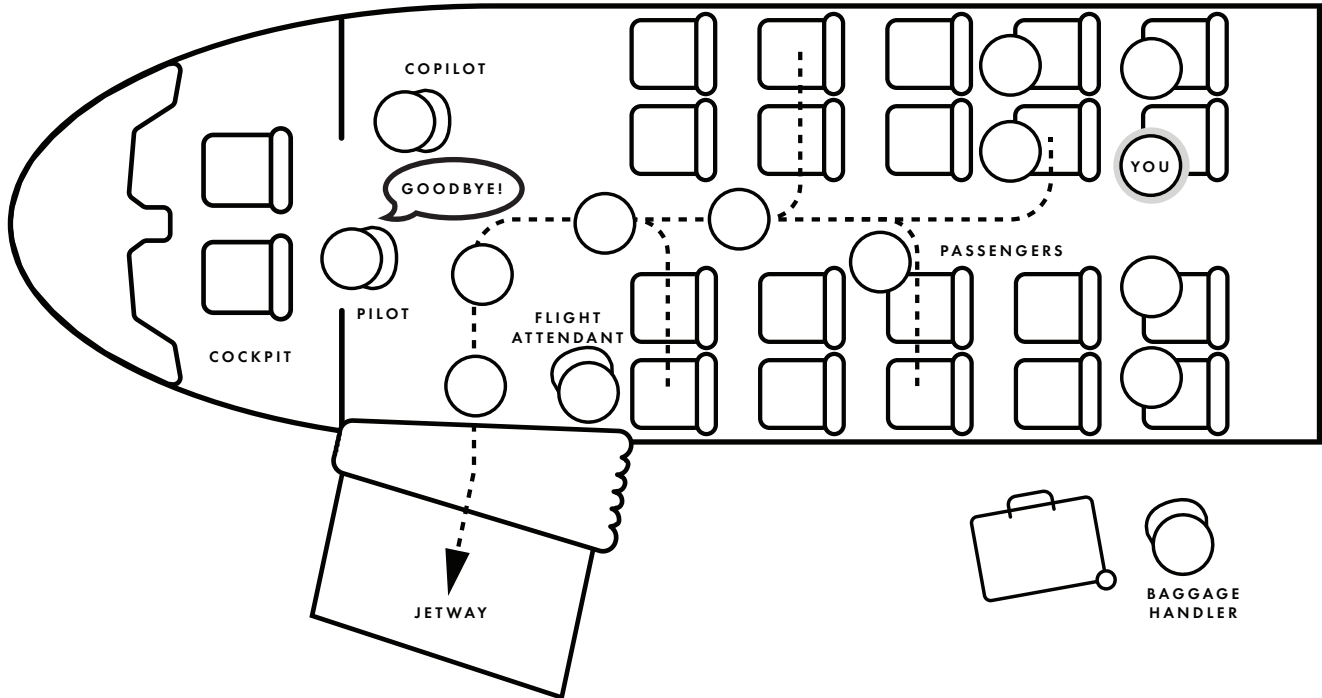

You will get to say goodbye to your pilots, walk across the jet bridge again, and arrive at a gate like the one you entered.



or



At this point, you will either go to a different plane for the next flight on your adventure, or you will go with your family to pick up any bags you left when you checked in.

# YOU DID IT!

Congratulations! You are an expert flier! Color this award to celebrate your success. Once you are back home, hang it up to show everyone how super you are!



Now you are ready to fly anywhere! The Tallahassee International Airport looks forward to seeing you at the start of your next adventure!

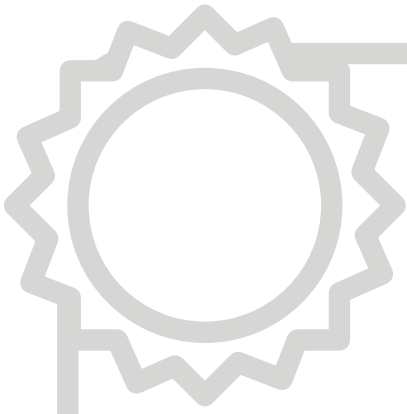

**TALLAHASSEE**  
INTERNATIONAL AIRPORT  
*An exceptional way to fly.*

When you fly **TLH**,

---

there's always a place to  
come **home** to.



**CITY OF  
TALLAHASSEE**



FOLLOW, LIKE AND SUBSCRIBE TO THE CITY OF TALLAHASSEE'S GENERAL NEWS ACCOUNTS BY SEARCHING FOR **@CITYOFTLH** ON FACEBOOK, TWITTER, INSTAGRAM AND YOUTUBE.

